

















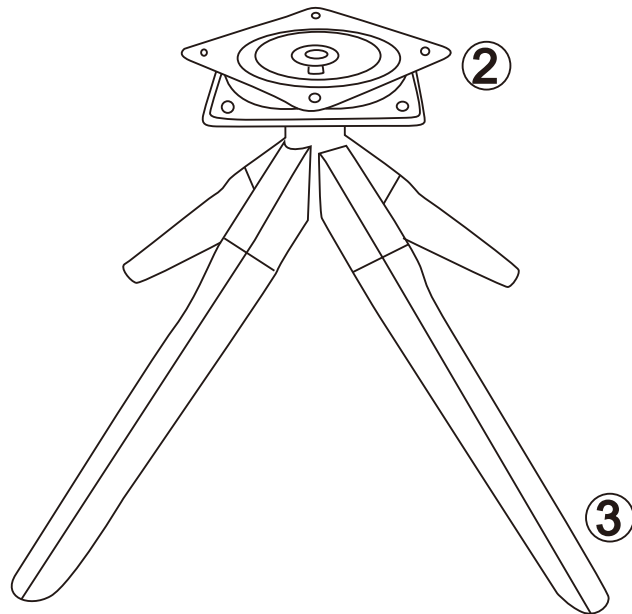
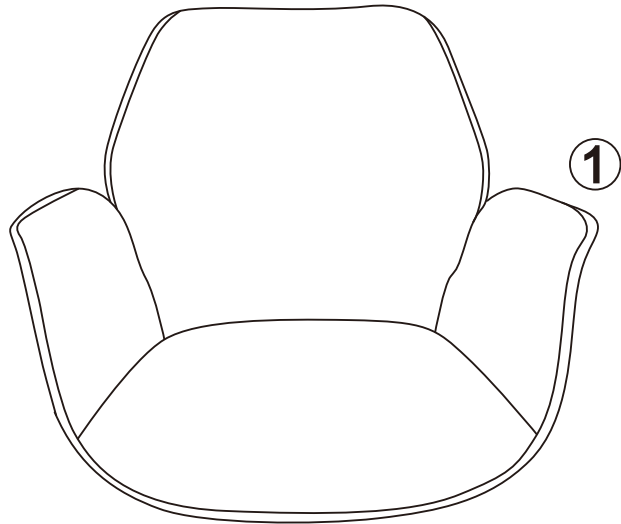



①	1	600*620*510mm	
②	1	230*230*180mm	
③	4	395*50*30mm	

A*6	B*4	C*1	D*1	E*4	F*8	G*4	H*1	I*1
 M6*20	 M6*20	 M6*30	 M6*18	 M6	 M6*16*1		 M6	 M5





①*1 	②*1 	③*4 	A*6  M6*20	B*4  M6*20	C*1  M6*30
D*1  M6*18	E*4  M6	F*8  M6*16*1	G*4 	H*1  M6	I*1  M5

1

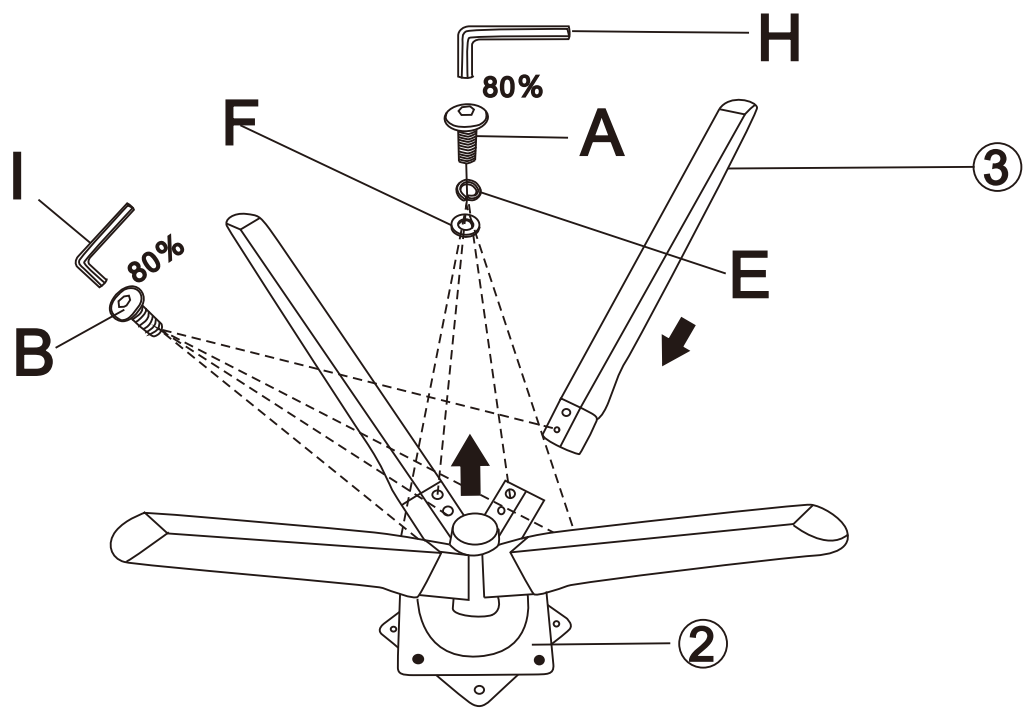
A*4  M6*20	B*4  M6*20	F*4  M6*16*1	E*4  M6	H*1  M6	I*1  M5
---	---	--	--	--	--





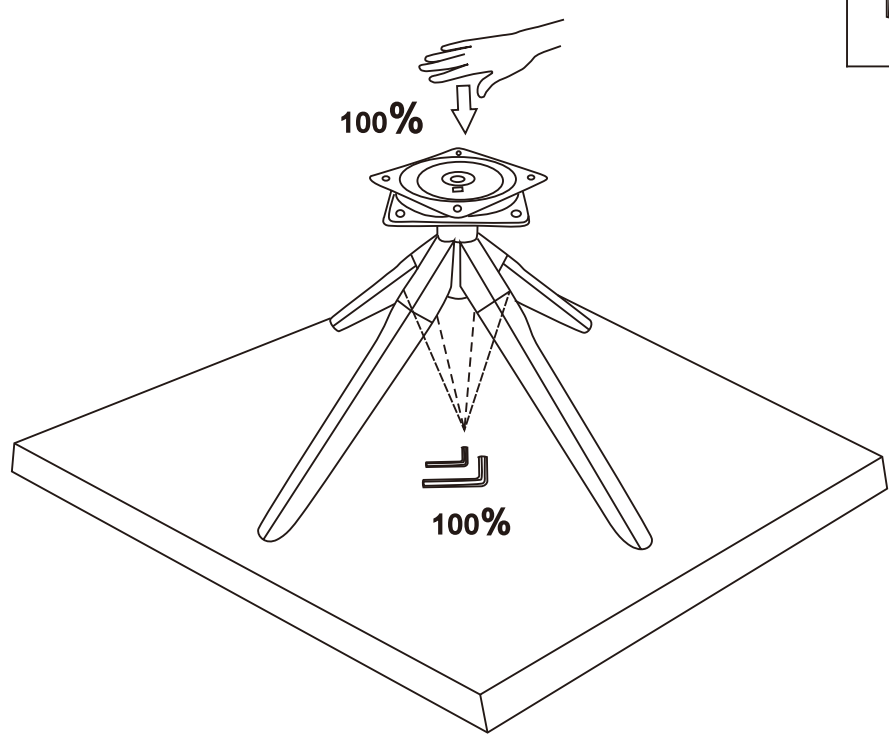

2

H*1  M6	I*1  M5
--	--

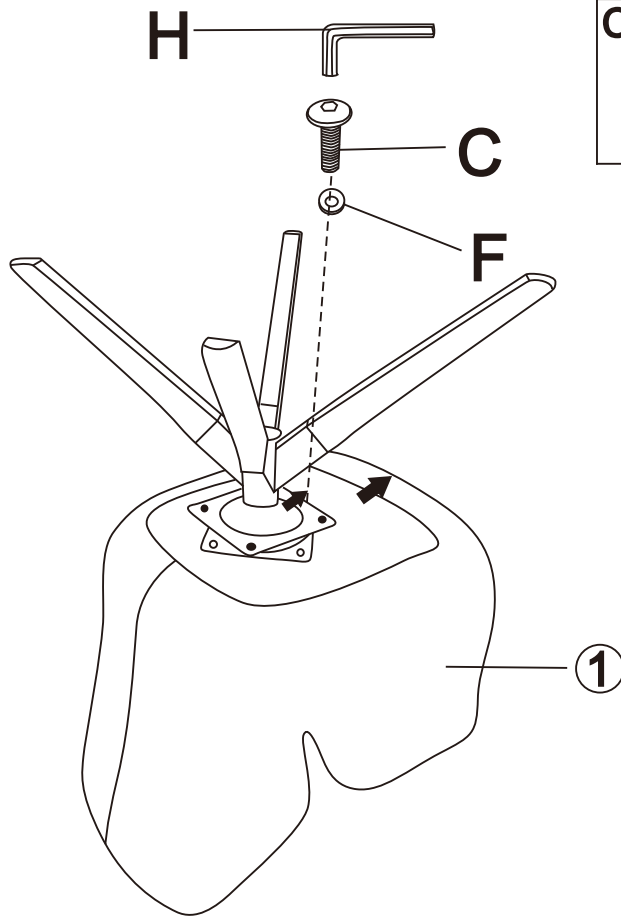





3

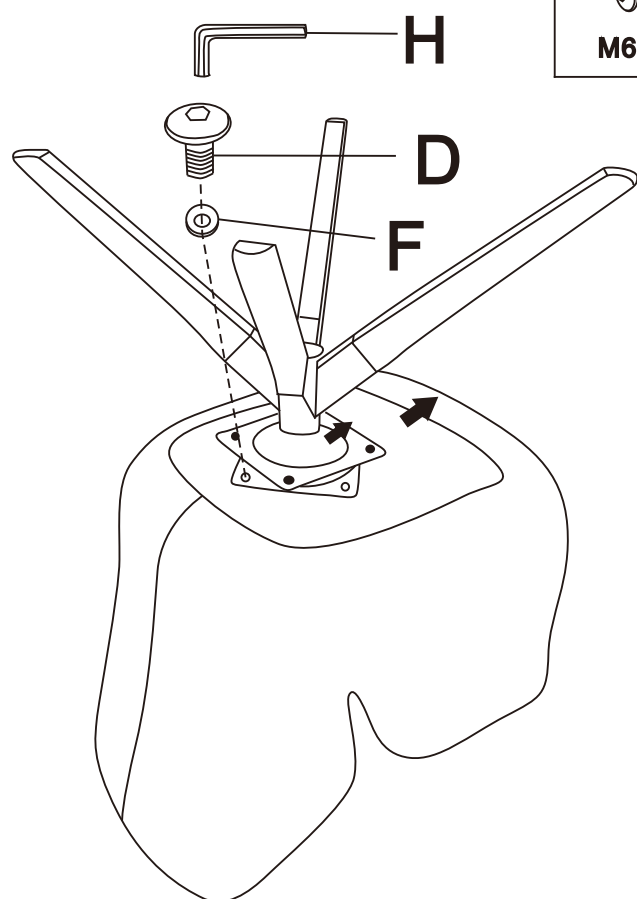

C*1  M6*30	F*1  M6*16*1	H*1  M6
--	--	---





4

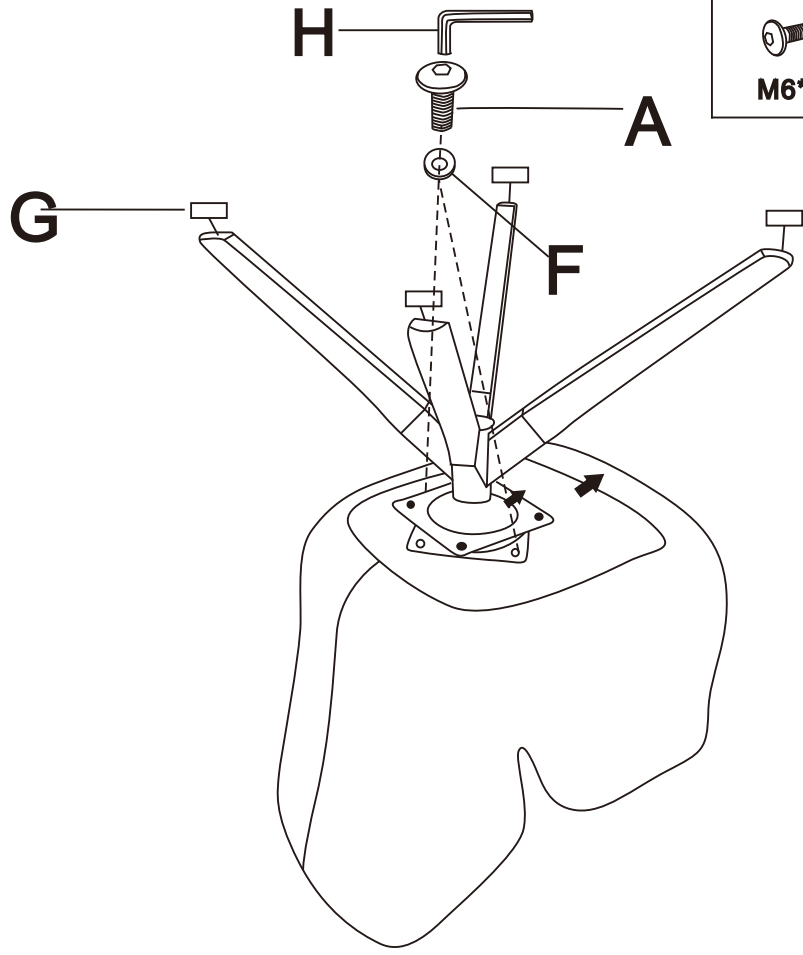

D*1  M6*18	F*1  M6*16*1	H*1  M6
--	--	---

5



A*2  M6*20	F*2  M6*16*1	G*4 	H*1 
--	---	---	---

6

