



Ena bed

Product sheet

design by
Salih Teskeredžić



Ena bed

Product facts

Materials

Body	Solid oak
Finish	Hardwax oil
Headboard	White fabric upholstery

Technical features

Body

Ena bed's body structure is entirely made out of solid wood - oak. Frame sides have characteristic 45 degree angle joints connected with metal brackets.

Headboard

Demountable headboard is upholstered in white microfiber fabric with solid oak edging. Options without headboard are also available on request.

Finish

Solid wood finish is available in two plant-based Hardwax oil finishes (colours), which retain the wood's natural state, as a white or natural oil.

Cleaning

Please see [Product](#) or [Material](#) page on our website.

Mattresses and slats

Mattresses and slats are not included in the Ena bed, while the basic slats (6 cm high) are available on request.

Slats available on request come in two separate parts and are combined together in one bed frame (dimensions of each part is 1/2 bed internal frame width).

Bed internal frame width = mattress nomenclature width + 1 cm; internal frame depth = mattress nomenclature depth + 1 cm.

Notes to consider

Variations

Natural variations in wood color and surface may occur. Regular maintenance will ensure the wood preserves its authentic beauty and can last for generations.

Product changes

Please note that Gazzda reserves the right to alter construction and design without notice.

Dimensions (tolerances)

The dimensions shown are indicative, they may vary due to the natural properties of wood, season, or manufacturing processes. Deviations from the specified size may occur, usually no more than 1 cm.

For all additional inquiries regarding Ena bed please feel free to [contact us](#).

Ena bed 160 x 200

Frame Solid oak, Headboard White fabric

Version: 7-1-2022

Basic info

Design Salih Teskeredžić

Mattress size W: 160, D: 200

Product size W: 170, D: 217, H: 87

Package - Fittings W: 40, D: 19, H: 17

Package - Long sides W: 218, D: 24,5, H: 13

Package - Short sides W: 175,5, D: 24, H: 16

Package - Headboard W: 166, D: 70, H: 10,5

Volume (total) 0,27 m³

Net weight 54,4 kg

Gross weight 59,7 kg



Item no. 0B2

Internal space	Width	Depth	Height
Frame size	161	201	14,5
Mattress size	160	200	

Assembly 45 min / 2 persons

Frame	Height
Up to frame	20
Normal frame	20

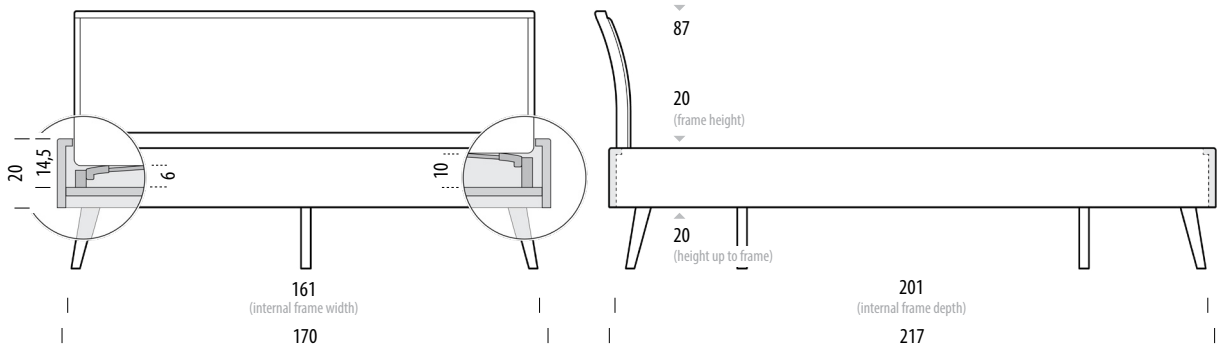

Ena bed 180 x 200

Frame Solid oak, Headboard White fabric

Version: 7-1-2022

Basic info

Design Salih Teskeredžić

Mattress size W: 180, D: 200

Product size W: 190, D: 217, H: 87

Package - Fittings W: 40, D: 19, H: 17

Package - Long sides W: 218, D: 24,5, H: 13

Package - Short sides W: 195,5, D: 24, H: 16

Package - Headboard W: 186, D: 70, H: 10,5

Volume (total) 0,29 m³

Net weight 56,5 kg

Gross weight 62,1 kg



Item no. 0B3

Internal space	Width	Depth	Height
Frame size	181	201	14,5
Mattress size	180	200	

Assembly 45 min / 2 persons

Frame	Height
Up to frame	20
Normal frame	20

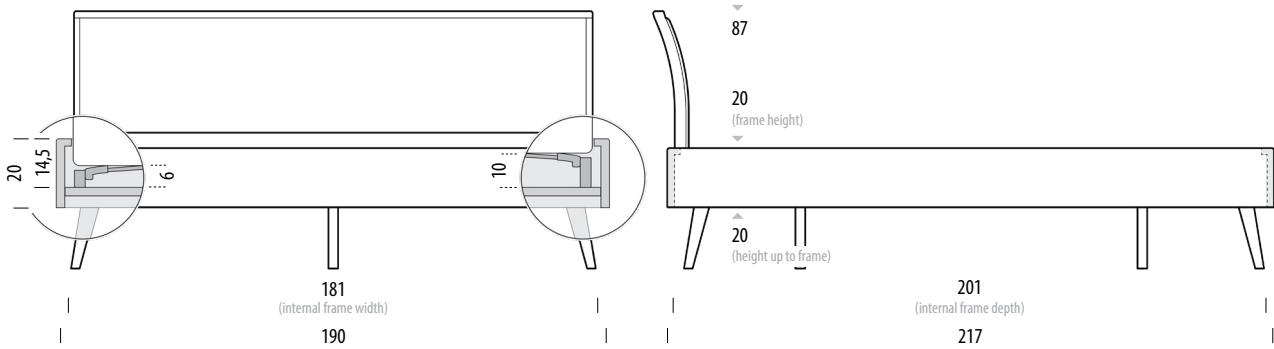

Ena bed

Possible mattresses and slats combinations

0cm 20 50 100 150 200 250

Scale: 1:40

Internal frame height detail Combinations for **6 cm** high slats

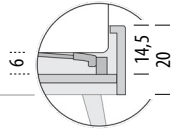

Slats and mattress not included

Basic sprung slats (6 cm high) are available on request as a separate product.

Internal frame height detail Combinations for **10 cm** high slats

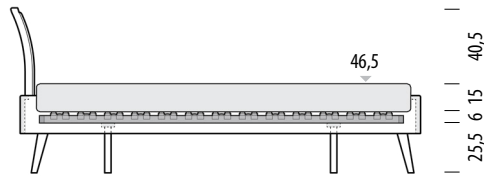
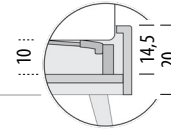

Mattress height 15 cm
Height from the floor 46,5 cm

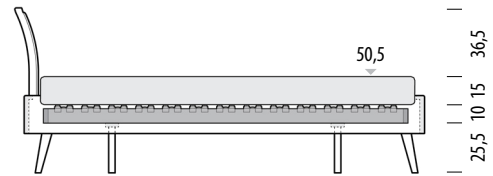

Mattress height 15 cm
Height from the floor 50,5 cm

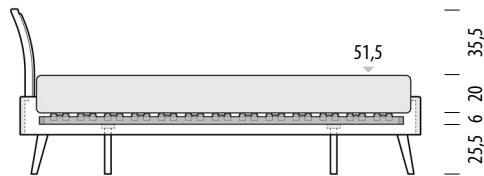

Mattress height 20 cm
Height from the floor 51,5 cm

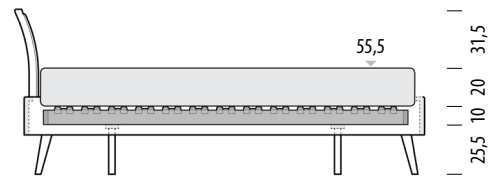

Mattress height 20 cm
Height from the floor 55,5 cm

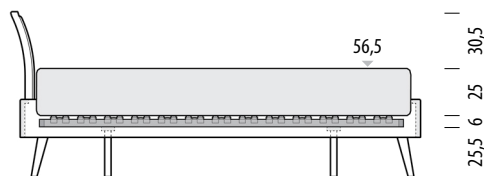

Mattress height 25 cm
Height from the floor 56,5 cm

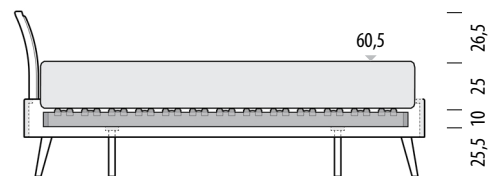

Mattress height 25 cm
Height from the floor 60,5 cm

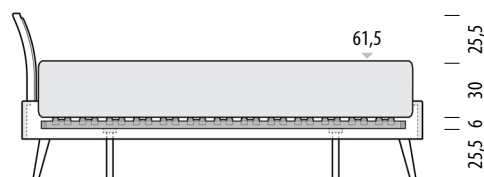

Mattress height 30 cm
Height from the floor 61,5 cm

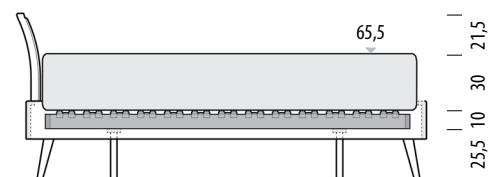

Mattress height 30 cm
Height from the floor 65,5 cm

Ena bed

Available materials

Frame | Solid oak

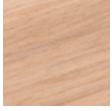

Oiled
1015
White oil

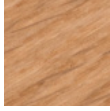

Oiled
1505
Natural oil